

1

2

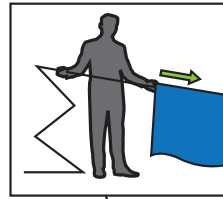

3

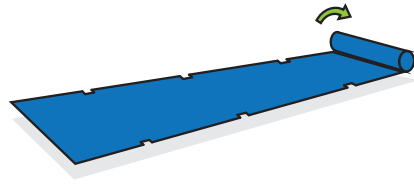
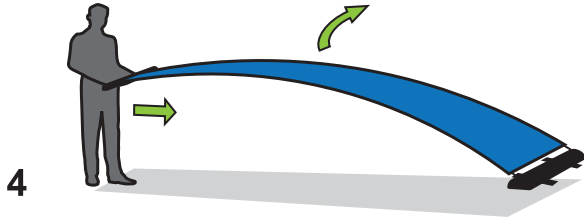
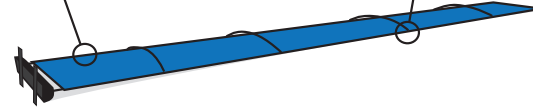
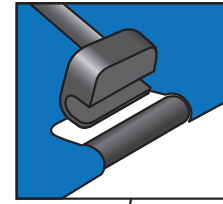

4

5

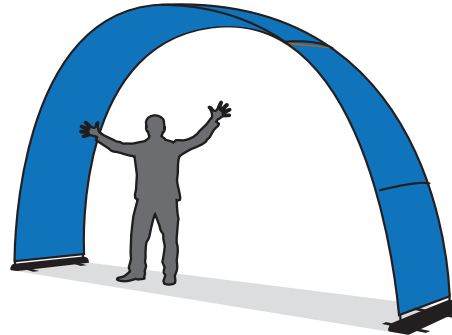

BANNERBOW[®]
DESIGNING PORTABLE SPACE

SET UP GUIDE FOR OUTDOOR

CONTENT

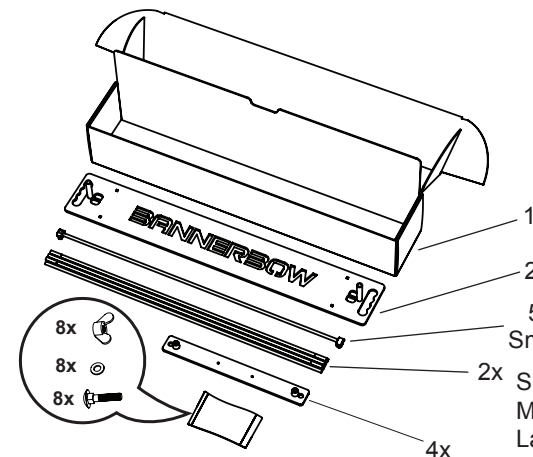

1x

2x

5x

6x

7x

2x

4x

Small Medium Large

Small: 7 linked fiberglass poles
Medium: 9 linked fiberglass poles
Large: 11 linked fiberglass poles

ASSEMBLE FOOT SUPPORTS

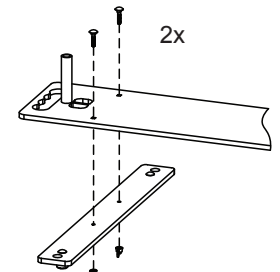

2x